

Compact M5 cylinder pressure sensor

Many development challenges – one sensor

Type 6054C...

The new generation M5 cylinder pressure sensor has the perfect combination of performance and durability, such that it can be deployed across the full engine development process. It has the required sensitivity and accuracy for early thermodynamic and efficiency studies, combined with the robustness needed for later calibration and validation activities. In addition, the sensor has been designed to provide the user with efficiency and low cost of ownership through the sensors working lifetime. The 6054C sets the standard for in-cylinder sensors required for the next generation of combustion system technologies.

- Mounting dimensions compatible to all sensors Types 6052 and 6054
- Excellent strain interference rejection (latest Anti-strain design), thus ideally suited for direct mounting
- Minimal sensitivity shift across the working temperature range
- Very low linearity deviation
- High thermal shock resistance
- High durability without compromising thermodynamic behavior
- Very compact design

Description

The Type 6054C is a front-sealing sensor in a M5 × 0.5 bore – and is therefore suitable for various installation techniques, both with or without a mounting sleeve. However, the excellent strain rejection, due to the decoupled measuring element from the sensor housing, allows installations with no mounting sleeve (i.e. direct installations), to achieve excellent results, irrespective of strain effects. It is therefore ideally suited to modern engine applications, for the development of powerful compact engines that employ complex cylinder head geometry. This sensor is also ideal for motorcycle and small engine development tasks, as well as in-vehicle measurement applications later in the development cycle.

The new PiezoStar crystal from Kistler offers a high sensitivity combined with thermal and mechanical stability. Due to the very compact design and the high natural frequency of the sensor, the influences of engine vibrations, such as valve-closing, are minimized.

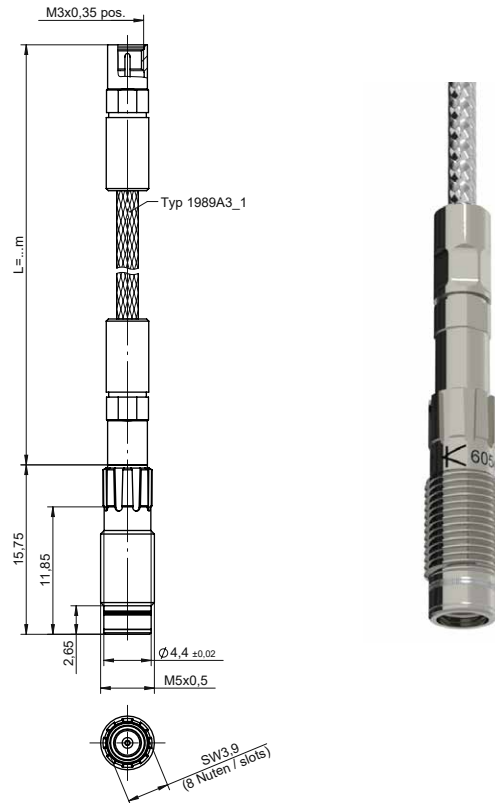

Technical data

Measuring range	bar	0 ... 300
Calibrated ranges (23°C, 200°C, 350°C)	bar	0 ... 100, 0 ... 150, 0 ... 200, 0 ... 300
Overload	bar	350
Sensitivity (at 23°C)	pC/bar	-17
Natural frequency (measuring element)	kHz	≈185
Linearity (at 23°C)	%FSO	±0.3
Tightening torque, greased	N·m	1.5
Shock resistance (half sinus 0.2 ms)	g	≥2 000
Acceleration sensitivity		
axial	mbar/g	0.8
radial	mbar/g	0.2
Sensitivity shift		
23°C ... 350°C	%	± 0.75
200 ± 50°C	%	± 0.25

6054C_003-458e-11.21

Technical data (continue)

Operating temperature range	°C	-20 ... 350
Temperature, min./max.	°C	-40 ... 400
Thermal shock error (at 1,500 1/min, IMEP = 9 bar)		
Δp (short-term drift)	bar	±0.25
ΔIMEP	%	±1.5
Δp _{max}	%	±1.0
Insulation resistance (at 23°C)	Ω	≥10 ¹³
Capacitance sensor	pF	8
Connector, sapphire insulator		M3x0.35
Protection rating, with cable Type 7 (IEC 60529)	IP	65
Weight sensor	g	1.5

Installation

The sensor with connected cable is installed using the mounting key Type 1300A185A and the torque wrench Type 1300A17. For sensors with PiezoSmart the slotted mounting key Type 1300A185B is suitable. The key Type 1300A185C serves to hold the sensor securely whilst attaching the cable assembly.

Direct installation:

The pressure sensor Type 6054C can be installed directly into the cylinder head. The length of the access passage is dependent on the material (Fig. 1). The bore must be machined exactly to specification (Fig. 1). Kistler tools allow you to achieve the required tolerances. The bore must be machined in one operation. Before mounting the sensor, the use of the reaming tool Type 1300A79 is mandatory.

Sleeve Installation:

Where space allows, or where the cylinder head fluid passages must be crossed, it is advisable to use a mounting sleeve. Another advantage of sleeves is that the actual sensor bore can be machined very accurately within the sleeve and the length of the access channel can be minimized. Fig. 2 shows an example of a mounting sleeve Type 6595AQ ... with M7 x 0.75 thread. On request Kistler will design and manufacture a specific sleeve for your application.

Maintenance

Kistler recommends an annual calibration from the first use of the sensor. For further information refer to the instruction manual or contact your Kistler representative.

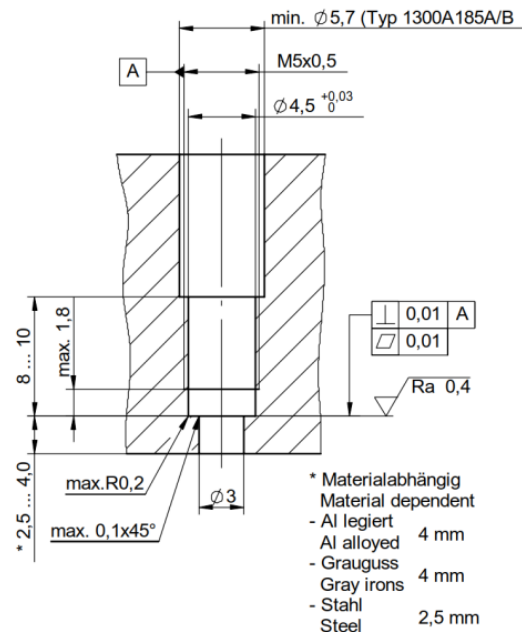

Fig. 1. Mounting bore

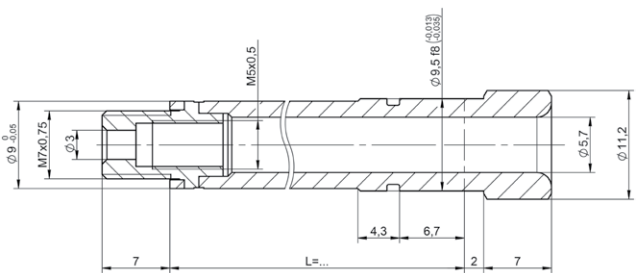

Fig. 2. Mounting sleeve M7 Type 6595ASP...

6054C_003-458e-11.21

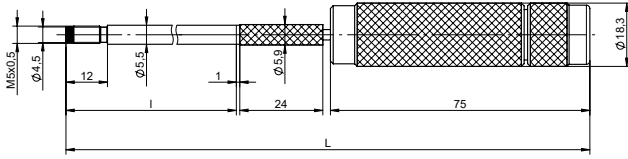

Fig. 3. Reamer Type 1300A79...

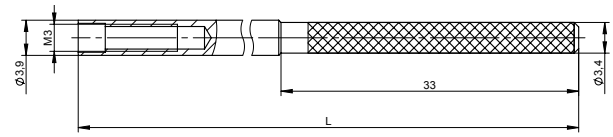

Fig. 9. Extraction tool Type 1349 for dummy sensor Type 6405A3

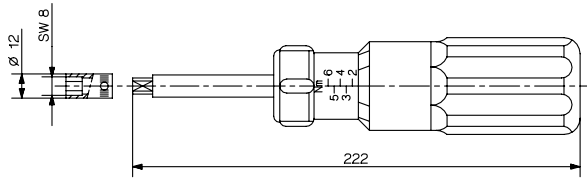

Fig. 4. Torque wrench Type 1300A17

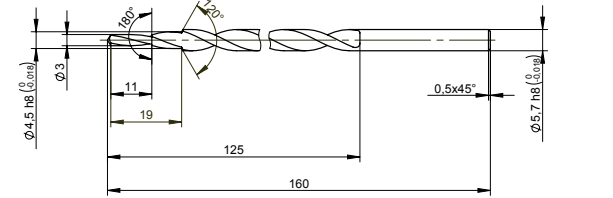

Fig. 10. Step drill Type 1300B22

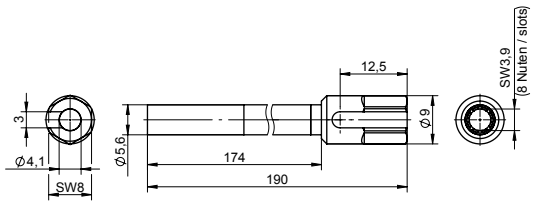

Fig. 5. Mounting key Type 1300A185A

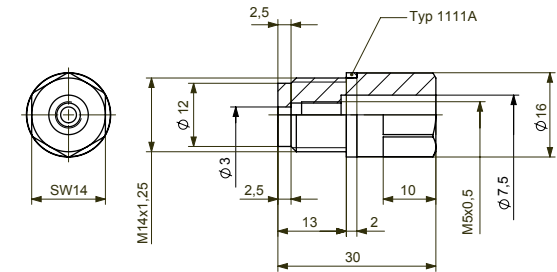

Fig. 11. Engine adapter M14 Type 6585AQ01

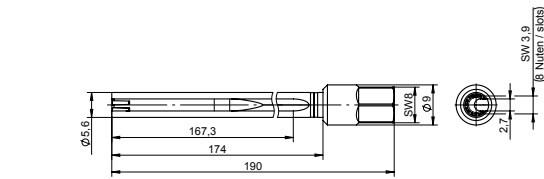

Fig. 6. Slotted mounting key Type 1300A185B for sensors with PiezoSmart

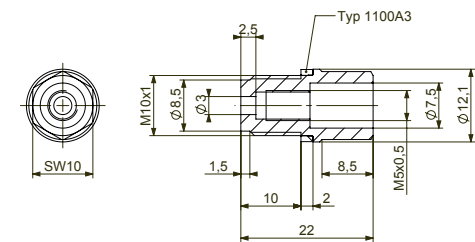

Fig. 12. Engine adapter M10 Type 6595A1Q01

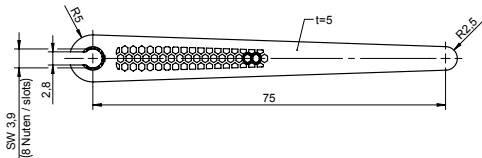

Fig. 7. Tool for cable mounting Type 1300A185C

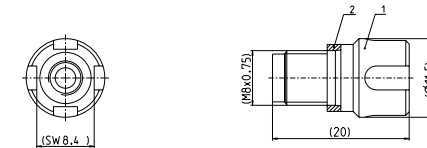

Fig. 13. Engine adapter M8 Type 6595Q01

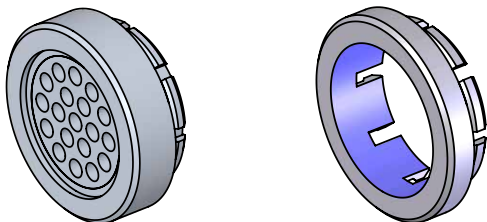

Fig. 8. Patented flame guard Type 6539A1Q01, diaphragm protection ring Type 6539A2 (both can be mounted without tools)

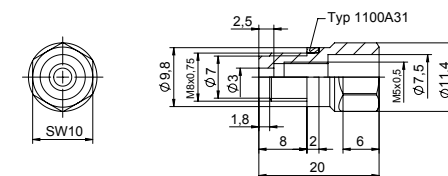

Fig. 14. Engine adapter M8 Type 6595

6054C_003-458e-11.21

Scope of delivery

- Pressure sensor
- Connecting cable acc. to ordering key
- Calibration certificate
- Adapter M3x0.35 neg.–BNC pos. (not for PiezoSmart)

Type/Art. No.

6054C

- Mounting sleeve M7x0.75 (custom made) 6595ASP...
- Temperature sensor 6054CT
- Reaming tool for sensor mounting surface
 - L = 162 / l = 60 1300A79
 - L = 273 / l = 170 1300A79Q01
 - L = 323 / l = 220 1300A79Q02
- Protective cap for sensor plug M3x0.35 1887A

Optional accessories

- PiezoSmart extension cables
 - L = 1 m 1987B1
 - L = 2 m 1987B2
 - L = 10 m 1987B10
- Replacement connecting cables, PFA steel braiding
 - L = 1 m 1989A311
 - L = 2 m 1989A321
 - L = 3 m 1989A331
 - with PiezoSmart, L = 1 m * 1985A8S311
 - with PiezoSmart, L = 2 m * 1985A8S321
 - with PiezoSmart, L = 3 m * 1985A8S331
- Replacement connecting cables, FPM oil-tight
 - L = 1 m 1989A711
 - L = 2 m 1989A721
 - L = 3 m 1989A731
 - with PiezoSmart, L = 1 m * 1985A8S711
 - with PiezoSmart, L = 2 m * 1985A8S721
 - with PiezoSmart, L = 3 m * 1985A8S731
- Patented flame guard, can be mounted without tools 6539A1Q01
- Diaphragm protection ring, can be mounted without tools 6539A2
- Dummy sensor 6405A3
- Extraction tool for dummy sensor 6405A3 1349
- Adapter for pressure generator Type 6904A 6585A
- Step drill 1300B22
- Mounting key standard (not slotted)
 - Ø5.6 mm, L = 190 mm 1300A185A
 - Ø5.6 mm, L = 267 mm 1300A185AQ01
- Mounting key for PiezoSmart (slotted)
 - Ø5.6 mm, L = 190 mm 1300A185B
 - Ø5.6 mm, L = 267 mm 1300A185BQ01
- Tool for cable mounting 1300A185C
- Torque wrench 1300A17
- Engine adapter
 - Adapter HEX10 M8x0.75x-M5x0.5 6595
 - Adapter claw M8x0.75x-M5x0.5 6595Q01
 - Adapter HEX12 M10x1-M5x0.5 6595A1
 - Adapter HEX10 M10x1-M5x0.5 6595A1Q01
 - Adapter HEX14 M14x1.25-M5x0.5 6585AQ01
- Mounting key for adapter 6595Q01 1300A73Q02

* with factory calibration data, state SN with order
© www.kistler.com

Ordering key

PiezoSmart	
Without PiezoSmart (standard)	–
With PiezoSmart (standard)	S

Cable version	
PFA with steel braiding (standard)	3
FPM oil-proof	7

Cable length	
1 m (standard)	-1
2 m (standard)	-2
3 m (standard)	-3

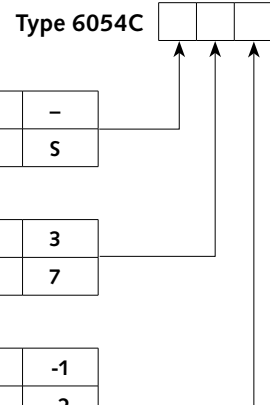

Order sample:

Standard sensor with PiezoSmart and 2 m FPM cable (oil-proof):
Type 6054CS7-2

Standard sensor without PiezoSmart and 1 m PFA cable:
Type 6054C-3-1

6054C_003-458e-11.21