

Multicomponent Force Plate

Type 9260AA...

for Gait and Balance Analysis in Biomechanics, F_z 0 ... 5 kN

This is a reasonably priced multicomponent force plate with aluminum sandwich cover plate for measuring ground reaction forces, moments and the center of pressure in gait and balance analysis.

- Excellent center of pressure (COP) accuracy
- Available in two different sizes
- Easy mounting
- Flexible, mobile application
- Versatile installation
- Threshold $F_z < 250$ mN

Description

Multicomponent force plate Type 9260AA... has an anti-slip textured finish and is available in two sizes (300x500 mm and 600x500 mm). Rather than having to be mounted on a frame like conventional force plates, it can simply be used on any flat surface. This drastically cuts installation costs.

The walkway solution Type 9418A... allows very cost-effective yet versatile options for installing one or more force plates.

Mounting frames are available for permanent or flush installation in the floor. It is also possible to install multiple frames that allow mounting of several force plates and dummies in different arrangements.

Despite the very wide measuring range (0 ... 5 kN), this force plate offers outstanding accuracy and linearity over the entire spectrum of applications and guarantees overload protection up to 8 kN for static (and considerably higher for impulse) loads.

These piezoelectric 3-component force sensors have very low crosstalk values and in conjunction with the special design principle ensure excellent center of pressure accuracy. Their long-term sensitivity stability makes Kistler force plates a reliable, cost-effective investment.

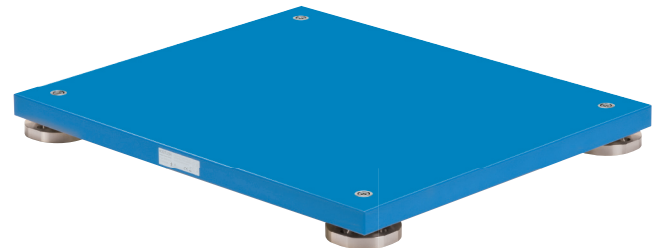

Application

This force plate is designed specifically for use in gait and balance analyses. Type 9260AA... has a built-in charge amplifier compatible with all of the common motion analysis systems. Type 9260AA6's low weight of just under 9 kg adds flexibility and portability. Force plate Type 9260AA3 (300x500 mm) is also ideal for use on steps.

Technical Data

Dimensions	Type 9260AA6	mm	600x500x50	
	Type 9260AA3	mm	298,5x500x50	
Measuring range	F_x, F_y	kN	-2,5 ... 2,5	
	F_z	kN	0 ... 5	
Overload	F_x, F_y	kN	-3/3	
	F_z	kN	0/8	
Linearity	%FSO		$< \pm 0,5$	
Hysteresis	%FSO		$< 0,5$	
Crosstalk	$F_x \leftrightarrow F_y$	%	$< \pm 2,5$	
	$F_x, F_y \rightarrow F_z$	%	$< \pm 2,5$	
	$F_z \rightarrow F_x, F_y$	%	$< \pm 0,5$	
Max. COP error	a_x	mm	≈ 2	
	a_y	mm	≈ 2	
Natural frequency	Type 9260AA6	$f_n(x, y)$	Hz	≈ 400
		$f_n(z)$	Hz	≈ 200
	Type 9260AA3	$f_n(x, y)$	Hz	≈ 500
		$f_n(z)$	Hz	≈ 300
Operating temperature range		$^{\circ}\text{C}$	10 ... 50	
Weight	Type 9260AA6	kg	8,6	
	Type 9260AA3	kg	5,5	
Degree of protection	EN 60529:1992		IP52	

Technical Data (Cont.)

**Force Plate with Built-in 8-Channel Charge Amplifier
(4 Measuring Ranges)**

Calibrated partial range	F _x , F _y	kN	0 ... 0,25
	F _z	kN	0 ... 1
Calibrated range	F _x , F _y	kN	0 ... 1,25
	F _z	kN	0 ... 5
Sensitivity range 1	F _{xi} , F _{yi}	mV/N	≈37,5
	F _{zi}	mV/N	≈19,0
Sensitivity range 2	F _{xi} , F _{yi}	mV/N	≈7,5
	F _{zi}	mV/N	≈3,8
Sensitivity range 3	F _{xi} , F _{yi}	mV/N	≈3,8
	F _{zi}	mV/N	≈1,9
Sensitivity range 4	F _{xi} , F _{yi}	mV/N	≈1,9
	F _{zi}	mV/N	≈0,9

Ratio range	1:2:3:4		1:5:10:20 ¹⁾
Threshold		mN	<250 ²⁾
Drift	F _x , F _y	mN/s	<5
	F _z	mN/s	<10
Supply voltage		VDC	10 ... 30
Supply current		mA	≈45
Output voltage		V	0 ... ±5
Output current		mA	-2 ... 2
Control inputs (optocoupler)		V	5 ... 45
		mA	0,4 ... 4,4

¹⁾ ±0,5 % accuracy
²⁾ range 1 only

Conforms to the **CE** safety standards (73/23/EG) for electrical equipment and systems: EN 60601-1:2005, EN 61010-1:2001 and the EMC standards (89/336/EG): EN 60601-1:2005 (EN 55022 Class B), EN 61000-6-3:2004 (EN 55022 Class B), EN 61000-6-4:2001 (EN 55011 Class B), EN 60601-1:2005, EN 61000-6-1:2001, EN 61000-6-2:2005.

Dimensions

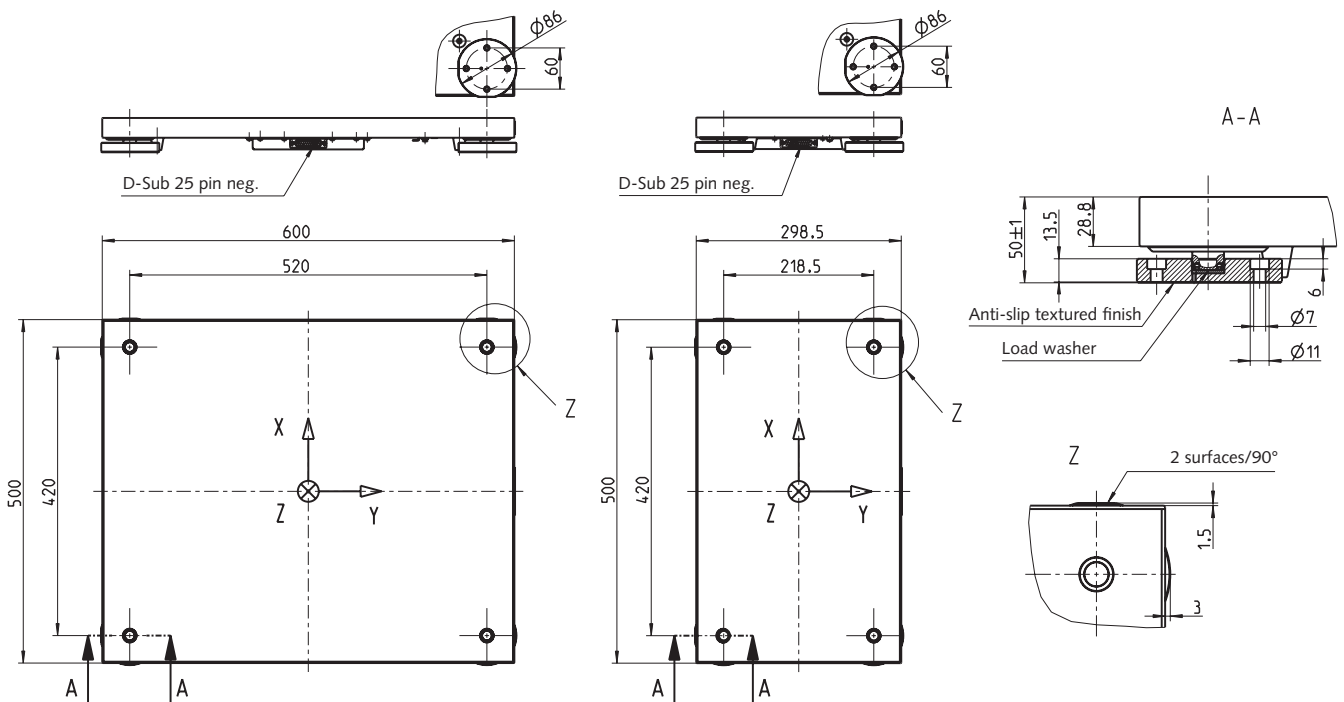

Fig. 1: Dimensions of multicomponent force plate Type 9260AA...

9260A_000-729e-02.14

Versatile Installation

Depending on the area of application, very short or very long step lengths for children or rehabilitation can be measured on the same station. As force plate Type 9260AA... comes two sizes, it can be combined in virtually any way with the available walkway components and mounting frames. This enables the measuring station to be tailored exactly to requirements while remaining flexible to accommodate occasional changes.

Walkway Type 9418A...

Various elements and dummies are available for assembling a walkway of any required length and width with force plates in different arrangements. To ensure a consistent surface the individual components of the walkway are provided with the same antislip finish as the force plates.

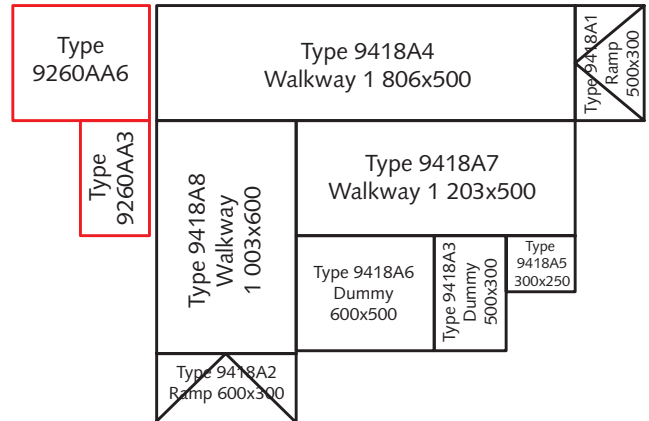

Fig 2: Walkway elements

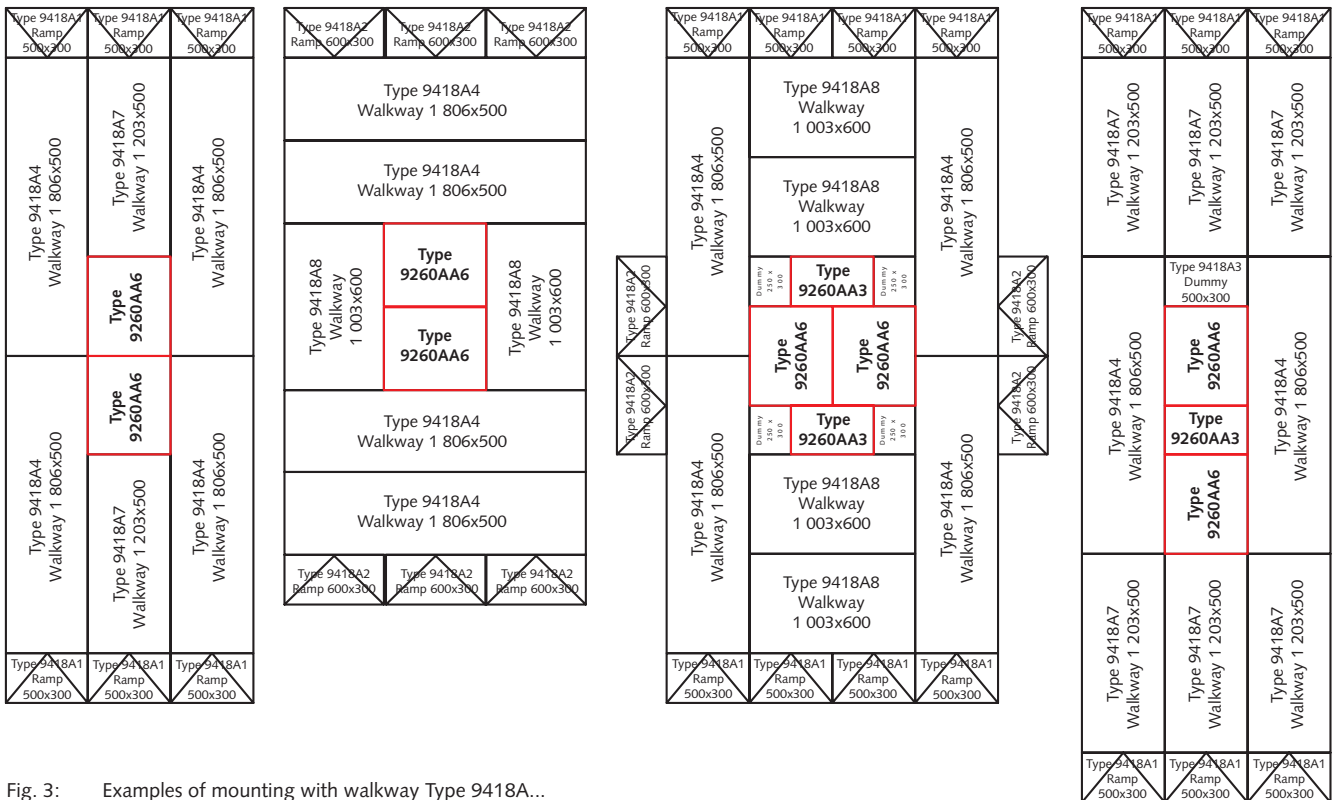

Fig. 3: Examples of mounting with walkway Type 9418A...

9260A_000-729e-02.14

Mounting Frame Type 9428...

Long-term or flush installation in the floor is accommodated by mounting frames Type 9428..., which are permanently bonded to the foundation with a suitable grout.

To retain installation flexibility, frames, which allow various mounting options, can also be installed to enable several force

plates to be used in a different position, or longitudinally and transversely at the same time, as required.

Dummies Types 9418A3 and 9418A6 can then be mounted on the frame instead of force plates of the same size.

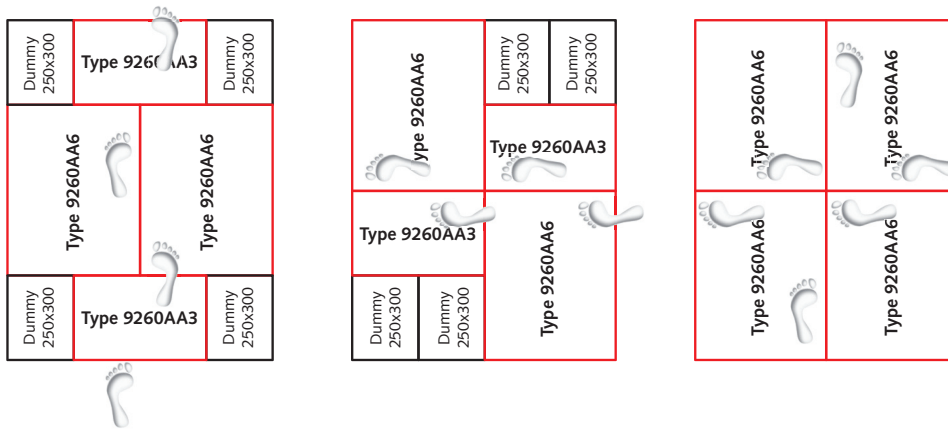

Fig. 4: Configurations with frame Type 9428A... using various arrangements of force plates

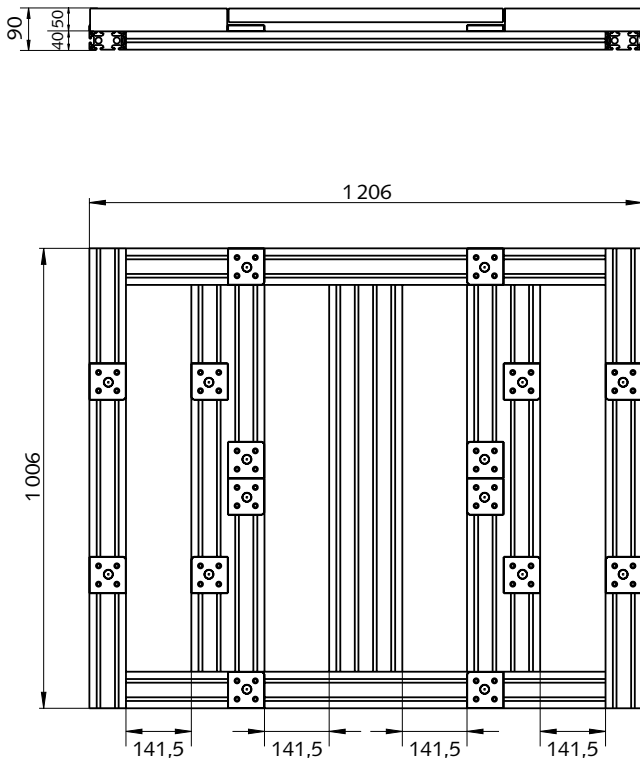

Fig. 5: Mounting frame Type 9428A1

BioWare®

BioWare software is the engine behind the force plate system. It collects data from the force plates, converts the trials into useful information and plots the results. BioWare also makes different evaluations of specific aspects of performance available.

The fact that the force plates and charge amplifiers are fully remotely controlled by BioWare makes the system extremely flexible and easy to use.

Gait Parameters

- Ground reaction force (GRF)
- Center of pressure (COP)
- Frictional torque T_z
- Force vector

Other Functions

- Moments, coefficient of friction (COF)
- Frequency analysis (FFT), statistics, digital filters
- Acceleration, velocity and displacement of the center of mass (COM)
- Work, energy, impulse load, statistics

Jump Parameters (e.g. SJ, CMJ, etc.)

- Jump force
- Power
- Jump height (COM)
- Force gradient (explosivity)

9260A_000-729e-02.14

Typical Measuring Chains



			
Force plate with charge amplifier Type 9260AA6	Connecting cable Type 1791A...	DAQ system (USB 2.0) Type 5691A1	Laptop (provided by user) with BioWare

Fig. 6: Configuration of a typical measuring chain with Kistler DAQ-System BioWare®

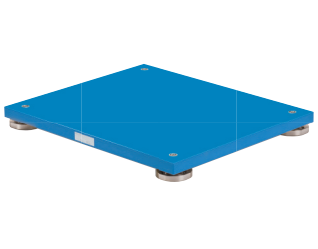
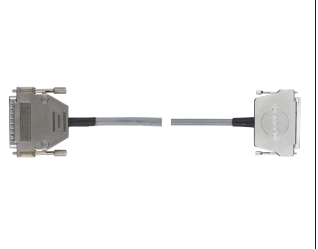

			Ch 1 = F _x 1+2 Ch 5 = F _z 1 Ch 2 = F _x 3+4 Ch 6 = F _z 2 Ch 3 = F _y 1+4 Ch 7 = F _z 3 Ch 4 = F _y 2+3 Ch 8 = F _z 4
Force plate with charge amplifier Type 9260AA6	Connecting cable Type 1793A...	External Control Unit (8xBNC fem.) Type 5233A2	DAQ system provided by user (8 analog channels)

Fig. 7: Configuration of a typical measuring chain with DAQ system provided by user

Included Accessories

- 1 Shim set
- 1 Voltage equalizing cable

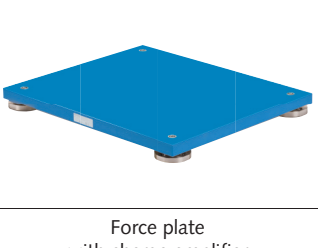
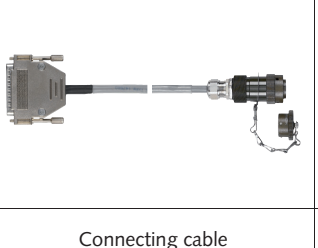
Type/Art. No.

- 7.050.214
- 5.590.175

Mounting Options

- Ramp, 500x300 mm 9418A1
- Ramp, 600x300 mm 9418A2
- Dummy, 300x500 mm 9418A3
- Walkway, 1806x500 mm 9418A4
- Dummy, 300x250 mm 9418A5
- Dummy, 600x500 mm 9418A6
- Walkway, 1203x500 mm 9418A7
- Walkway, 1003x600 mm 9418A8
- Mount. frame for 4 x Type 9260AA... 9428A1
- Mount. frame for 2 x Type 9260AA6 (long.) 9428A2
- Mount. frame for 2 x Type 9260AA6 (trans.) 9428A3
- Mount. frame for Type 9260AA6 or 2 x Type 9260AA3 9428A6

Optional Accessories

For Type 9260AA... with built-in charge amplifier

- 16ch DAQ system for BioWare (USB 2.0) 5691A1
- Connection cable for Type 5691A... 1791A...
- 64ch DAQ system for BioWare (USB 2.0) 5695B1
- Connection cable for Type 5695B... 1700A107A...
- External control unit (BNC out) 5233A2
- Connection cable for Type 5233A... 1793A...
- DAQ system for BioWare (PCI Bus) 2812A...

Type/Art. No.

Ordering Key

		Type 9260AA <input type="checkbox"/>
Multicomponent force plate		
Dimensions 300x500 mm	3	↑
Dimensions 600x500 mm	6	

BioWare® is a registered trade mark of Kistler Holding AG.