

NC Joining Module NCFH with Hollow Shaft Motor and Compact Design

Type 2151B...

The NC joining module Type 2151B... (in two sizes) with integrated piezoelectric force sensor for nominal forces of 1 ... 60 kN is excellent for use in assembly and joining processes monitored by force displacement.

- Force feedback control
- High measuring accuracy in two ranges
- High velocity
- Active compensation of process compression for exact positioning
- No external PC with special software required
- Absolute encoder, eliminates reference point determination
- Low maintenance

Description

The NC joining modules NCFH Type 2151B... consist of a robust housing with the displacement sensor, integrated absolute encoder, piezoelectric tension/compression force sensor and charge amplifier. The compressive or tension forces that impact the sensor create a proportional electrical charge in the piezoelectric measuring element, which is converted into an analog voltage signal by the integrated charge amplifier.

The drive motor is an electrically commutated hollow shaft AC servo motor which is controlled by a servo amplifier. This servo amplifier provides constant speed independent of load. Standard functions like block pressing, position pressing and force feedback controlled pressing as well as intermediate positioning are supported.

The NC joining module NCFH can be operated with the IndraDrive servo amplifier in combination with maXYmos NC Type 5847... . The communication between IndraDrive and maXYmos NC takes place in real-time via SERCOS III. Several field bus slave interfaces are available onboard for customer controlling. PROFIBUS, PROFINET, EtherNet/IP or even EtherCAT can be used with the maXYmos NC at the customer's choosing. Quality data can be transmitted via the Ethernet interface through different protocols and a visualization via VNC® or a data backup can be performed.



Application

The NC joining module NCFH Type 2151B... is excellent for application in assembly and joining tasks in automated production plants.

Vertical and horizontal installation is possible and is performed by wall or flange assembly. Process tooling should be installed on the ram (please refer to Fig. 1 and 2).

2151B_000-690e-02.17

Technical Data

Dimensions	mm	Fig. 1 and 2
Assembly options		wall or flange assembly
Weight		
size 1, 10 or 15 kN	kg	17
size 2, 30 kN	kg	69
size 2, 60 kN	kg	75
Max. tool weight ¹⁾		
size 1	kg	50
size 2	kg	100
Direction of measurement		compression/ tension
Measuring range		
size 1	kN	1, 2, 5, 10, 15
size 2	kN	15, 30, 60
Practical repeatability	mm	0,01
Length of stroke		
size 1	mm	200
size 2	mm	400
Tool holder	mm	Fig. 1 and 2
Holding brake	V/A	24/1
Max. movement speed	mm/s	300
Displacement sensor system		absolute encoder
Resolution	mm	0,001
Force sensor		piezoelectric
Temperature range	°C	10 ... 40

¹⁾ Possible radial forces must be considered independent of the mounting. Tool weight must be reduced using with manual loading.

A bending of the plunger depending on the tool weight must be considered for a horizontal installation.

Protection class		IP54
Linearity in all ranges	%FSO	≤1
Accuracy class force sensor	%	0,5
Service life of spindle (acc. to defined drive profile)	cycles	approx. 10 million
Short stroke		
size 1	mm	≤60
size 2	mm	≤110
Lubrication connection (exterior)		standard- lubricating nipple

Servo amplifier²⁾ Bosch-Rexroth Type 2180A...
Standard interface SERCOS III (internal bus)

Evaluation unit³⁾ maXYmos NC Type 5847...
Standard interface PROFIBUS, PROFINET,
EtherNet/IP, EtherCAT

Power supply VDC 24 ±5 %

²⁾ Servo amplifier see accessories data sheet 003-125 Type 2180A...

³⁾ Evaluation unit maXYmos NC Type 5847B... see data sheet 003-272

Comment about temperature:
According to the load profile the size 2 housing can heat up to 80 °C.
Cycle time <10 sec please contact technical service.

Dimensions

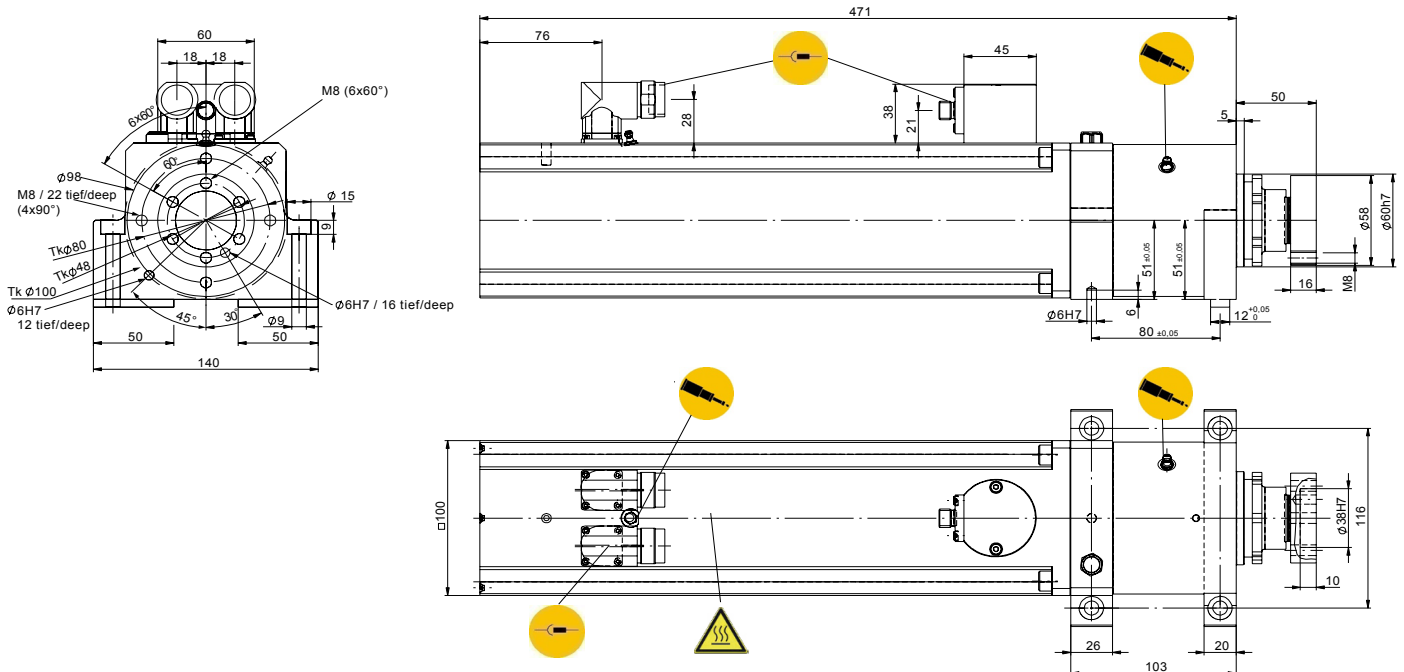

Fig. 1: Dimension NC joining module NCFH Type 2151B... size 1 for measuring range 1, 2, 5, 10 and 15 kN

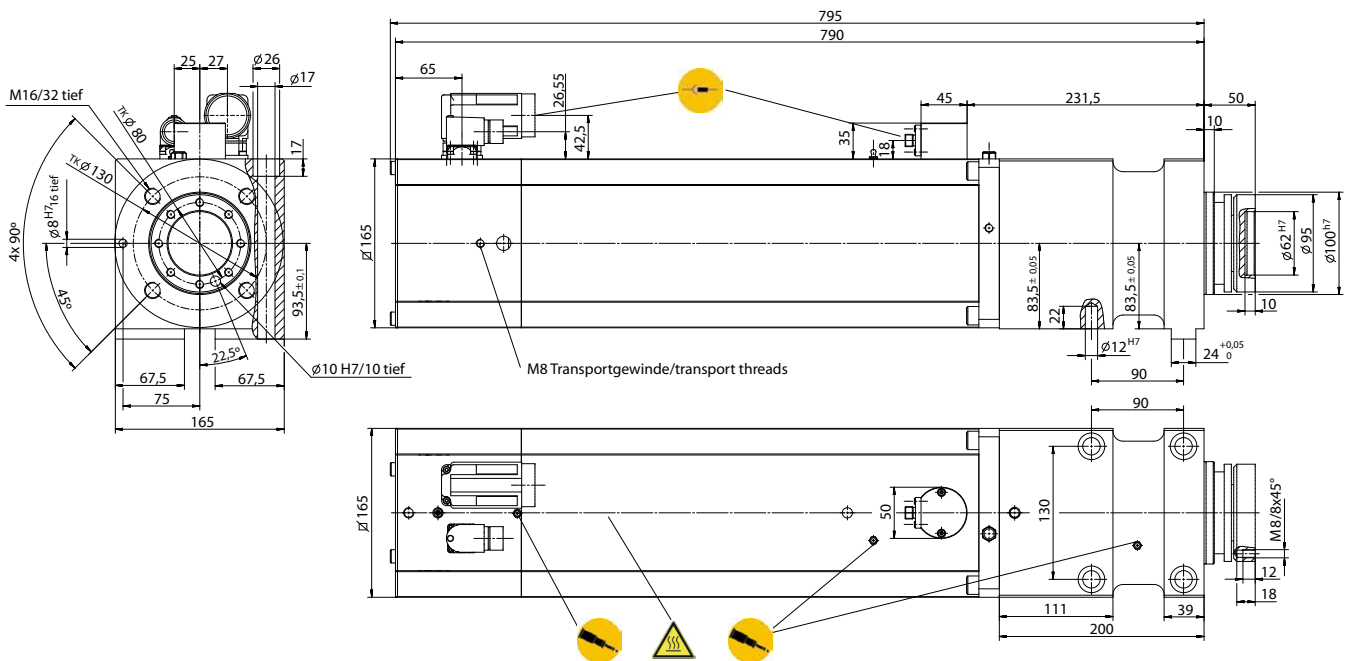





Fig. 2: Dimension NC joining module NCFH Type 2151B... size 2 for measuring range 30 and 60 kN

The radial forces (for example due to the weight of the tool) must be considered for the installation. An external guide may have to be provided for the plunger.

Warnings and Notes:

-  Lubrication points
-  Electrical connection points
-  Warning high temperatures

2151B_000-690e-02.17

Functional Principle with maXYmos NC Type 5847...

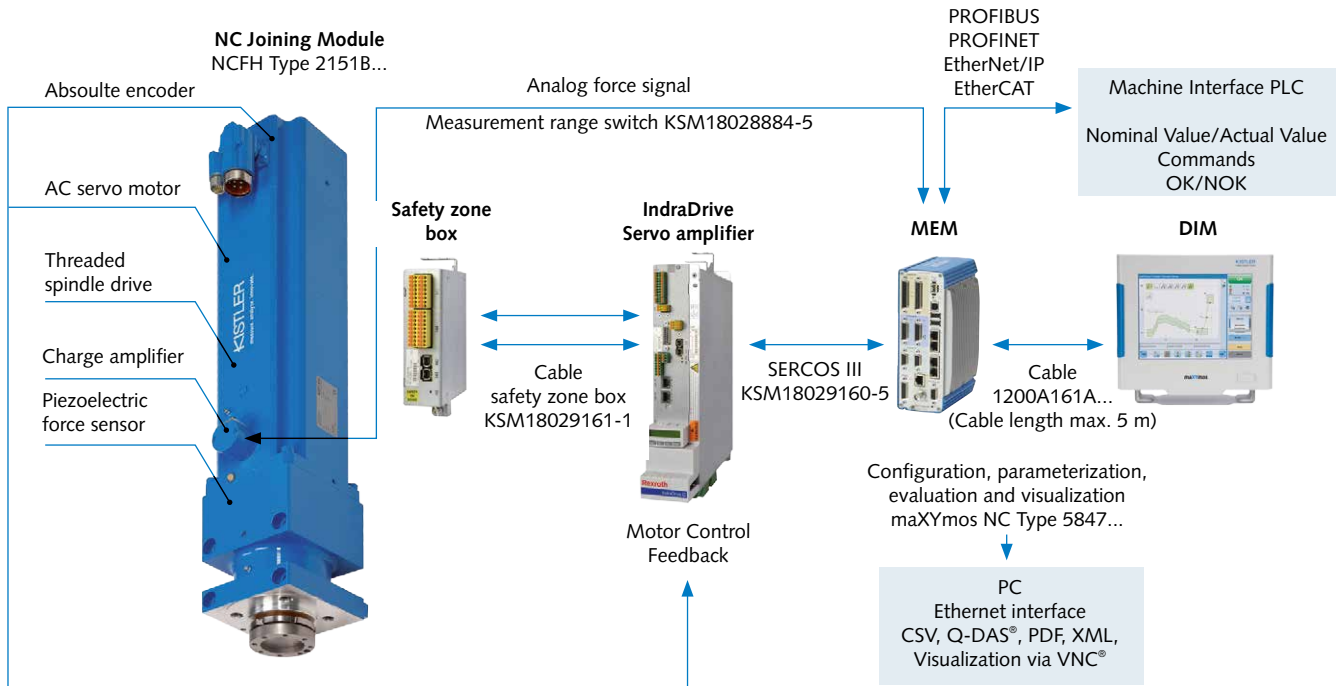

Fig. 3: Functional principle of NC joining system with NC joining module NCFH Type 2151B... and maXYmos NC Type 5847...

Included Accessories

- None

Optional Accessories

- Evaluation unit maXYmos NC⁴⁾ (MEM) 5847...
- Bearing rail adapter for 35 mm
Cap rail including 2 fastening
screws M3x10 5700A31
- Display module (DIM) with pedestal 5877AZ000
- Connection cable maXYmos
MEM on DIM, length 5 m 1200A161A5
- Servo amplifier²⁾ 2180A...

²⁾ Servo amplifier Type 2180A... see accessory data sheet 003-125

⁴⁾ Evaluation unit maXYmos NC Type 5847B... see data sheet 003-272

Cable

- NCFH Motor cable,
length 5 m for size 1 Type/Art. No. KSM333040-5
- NCFH Motor cable,
length 5 m for size 2 KSM333010-5
- NCFH Feedback cable,
length 5 m KSM18028885-5
- maXYmos Force transmitter cable,
length 5 m KSM18028884-5
- SERCOS III connection cable,
length 5 m KSM18029160-5
- Safety zone box cable,
2 cables required), length 1 m KSM18029161-1

Other length on request.

Ordering Key Servo Amplifier for NCFH

Power section for NC joining module			Type 2180A
NCFH	2151B to ≤015...	NCFH0215	□ □
NCFH	2151B 30...	NCFH0030	
NCFH	2151B 60...	NCFH0060	
Safety technology with safety zone box			SB

2151B_000-690e-02.17

Application Example

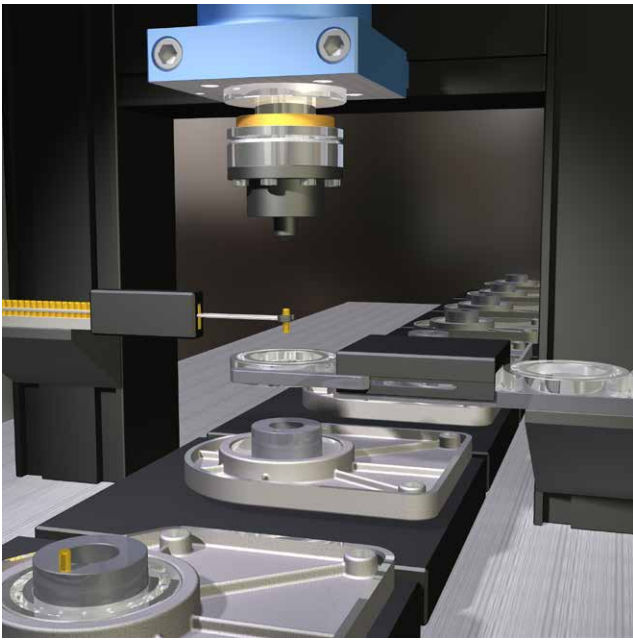

Fig. 4: Application example for joining process of bearing and pin

Ordering Key

Type 2151B

Meas. range 1	Meas. range 2	Stroke	Size	
2 kN	1 kN	200	1	02012001
5 kN	1 kN	200	1	05012001
5 kN	2 kN	200	1	05022001
10 kN	1 kN	200	1	10012001
10 kN	2 kN	200	1	10022001
10 kN	5 kN	200	1	10052001
15 kN	2 kN	200	1	15022001
15 kN	5 kN	200	1	15052001
30 kN	15 kN	400	2	30154002
60 kN	30 kN	400	2	60304002
60 kN	15 kN	400	2	60154002

Ordering Example

Type 2151B05022001

NC joining module NCFH **Type 2151B...**, measuring range 1: **5 kN**,
measuring range 2: **2 kN**, stroke: **200 mm**, overall size: **1**